

RELIABILITY OF LENTICULAR EXPANSION COMPENSATORS

Ph.D. eng. Gabriel BURLACU,
Technical University of Civil Engineering Bucharest

Abstract: Axial lenticular compensators are made to take over the longitudinal heat expansion, shock, vibration and noise, made elastic connections for piping systems. In order to have a long life for installations it is necessary that all elements, including lenticular compensators, have a good reliability. This desire can be did by technology of manufacturing and assembly of compensators, the material for lenses and by maintenance of compensator

Keywords: reliability, maintenance, lenticular compensators, life cycles, lens, technology

1. Introduction

In the energy industry, chemical, petrochemical, aerospace, food, mining and agriculture, they handle significant quantities of fluids, pressures and high temperatures.

The transport of these fluids is characterized by large values of working parameters and long distances. They require piping systems which is the technical solution required to take over the pipeline length variations.

Variations in length of the pipeline is due to the negative influence of low temperatures (-160°C) or high temperatures (600°C) of the circulating fluid and the ambient temperature in which installations must operate.

To avoid damage or even destruction facilities (cracking of welded joints of pipe and pipe elements, leakage loss, so on) due to changes in length, dilation thermal compensation systems were conducted, as follows:

- (i) expansion pounds U, L or Z;
- (ii) compensating sliding telescopic expansion (Fig. 1);

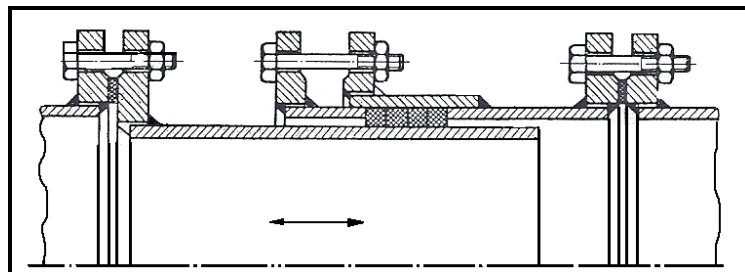

Fig. 1. Compensating sliding telescopic expansion

- (iii) compensating expansion with spherical articulations (Fig. 2);

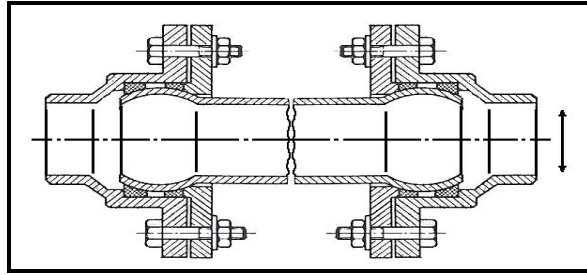

Fig. 2. Compensating expansion with spherical articulations

(i) expansion compensators lenticular (Fig. 3).

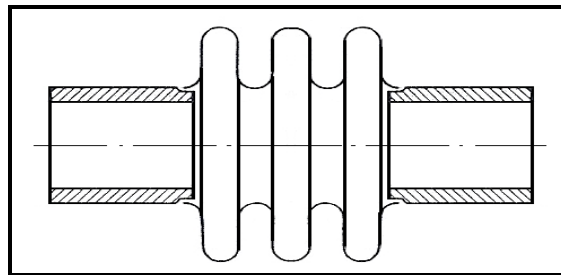

Fig. 3. Expansion compensators lenticular

Expansion pounds are used to acquire thermal dilations of the ducts which operate at relatively low pressures and fluid temperatures, assuming only axial expansions of pipelines.

Telescopic sliding expansion compensators are generally avoided to be used due to their low **reliability**, caused by rapid degradation of the sealing system seals.

To increase the reliability of such an activity, it is necessary a compensating preventive maintenance (greasing continuous) or corrective maintenance (replacement) of gaskets, an activity which is quite hard.

Expansion compensators with ball joints are also used quite limited, because they can retrieve only the plane perpendicular to their axis (Fig. 2) and the tightness is not good enough in order to prevent fluid losses.

Reliability spherical sealing is low, leading to an overall low **reliability** of the compensator.

2. Reliability of lenticular expansion compensators

2.1. General presentation

Lenticular expansion compensators are mostly used to acquire thermal dilations of pipelines, first of all due to their high **reliability** and their perfect tightness. It may also cover different areas: acquiring thermal expansion, shock absorber and vibration, make connections elastic piping systems.

The main element of this type of compensator **element elastic expansion is the lenticular** (lens, bellows, tears) that must be executed correctly, to have geometry very well studied, to having their sudden changes of direction in section thickness or profile.

In general, the lens is a simple circular or toroidal element that is welded, of which the welding process is done either by hand or electric welding in protective gas medium (WIG - Wolfram, Inert, Gas):

- (i) circumferential (Fig. 4);

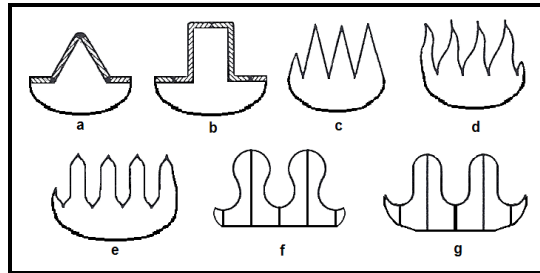

Fig. 4.

- (ii) longitudinal (Fig. 5).

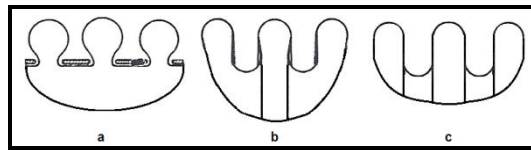

Fig. 5.

Reliability of lenticular compensator expansion is influenced by the following:

- (i) the reliability of the lens (geometric shape, technology implementation, material fabrication);
- (ii) execution quality welds, transverse and longitudinal;
- (iii) preventive maintenance work, applied during the operation of pipeline systems.

Lenticular expansion compensator can be considered as a set of three elements, the lens barrel stacks and flat flange or necks, elements connected in series through the circular welding seams (Fig. 6).

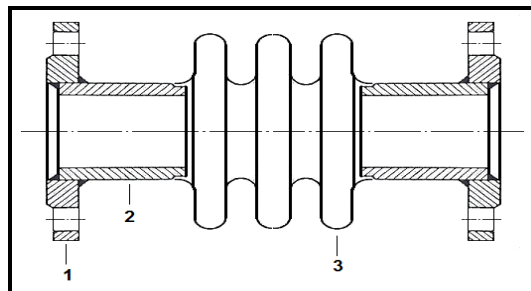

Fig. 6. - flange payment, 2 - socket pipe, 3 - elastic element lenticular

2.2. Experimental research on the reliability of expansion compensators lenticular

Reliability compensator $R_c(t)$ is given by the product reliability components, the lens R_l , R_t pipe, flange R_f as the relationship we have known for components connected in series:

$$R(t) = \prod_{i=1}^n R_i(t) \quad (1)$$

or

$$R_c = R_l R_t R_f \quad (2)$$

Note: It is the working assumption that the mechanical strength of circular and longitudinal welds is equal to that of other components.

Compensator is necessary for reliability and hence reliability R_c of lenticular elastic element is greater than the minimum allowable reliability required by the user for an industrial installation in which it is mounted.

Reliability of lenticular compensator expansion depends on:

- (i) the number and nature of fatigue load cycles;
- (ii) material quality of lenticular elements;
- (iii) the working fluid pressure and temperature;
- (iv) lens geometry (shape, wall thickness, step height);
- (v) chemical aggressiveness of the working fluid;
- (vi) the ratio between the number of lenses and their diameter;
- (vii) manufacturing technology of the lens (longitudinal seam or seam circular) and mounting technology of compensator components (flanges, pipe, elastic elements).

2.2.1. Influence of tiredness load cycles on the reliability of compensators

Principal application is submitted compensator, the entire life cycle is due to tiredness load of cyclic compression and tension.

Lenticular compensator is the main failure crack in the wall of the lens that appears after a variable number of cycles of demand, determined by observing the behavior of the compensator during installation or operation of laboratory tests.

There have been laboratory tested under conditions of axial compression and tension compensating lenticular of five nominal diameters, $D_n = 150, 200, 300, 400, 450$, with a total of three lenses each, and lens thickness $s = 2$ mm material fabrication, W1.4541 austenitic stainless steel sheet, obtaining the results in Table 1.

Alternating cycles were symmetrical and pulse.

Tensile strength for a pulsating cycle is greater than that for a symmetrical alternating cycle:

$$\sigma_0 = 1,5\sigma_{-1} \quad (3)$$

Tensions introduced into the material, which caused by tiredness cracking and breaking the lens is not only the mechanical but also thermal in nature. Thus, the austenitic stainless steel which runs lens compensators, thermal tiredness is a major show, because these materials have a low thermal conductivity and high thermal expansion.

Table 1: Test compensator store request periodic variables

No.	D_n	δ_1 displacement a lens (mm)	δ displacement total (mm)	nature cycles	N number cycles
1	150	3,5	10,5	σ_{-1}	2340
2	200	3,5	10,5	σ_0	4560
3	300	3,5	10,5	σ_{-1}	2620
4	400	3	9	σ_{-1}	2560
5	450	5	15	σ_{-1}	2480

The fatigue behavior of lenticular compensator expansion is determined by factors:

- (i) the maximum tension applied;
- (ii) large variation of the applied tension;
- (iii) a high number of cycles;
- (iv) the concentration of tension;
- (v) the corrosive effects of the working fluid;
- (vi) the working fluid temperature;
- (vii) residual stresses from materials used in the implementation of lenses, flanges and pipes.

Fig. 7 presents the cycle of tension varying effects produced in points 1, 2, 3, 4 expansion compensator lens surface with $D_n=300$.

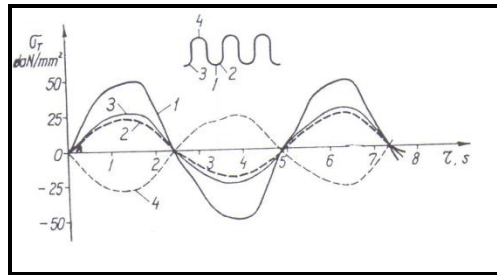

Fig. 7.

The diagram shows that the greatest tension is developed at the base and top lenses (points 1 and 4). The values of these tensions drop to half in areas of the lens attachment (2 or 3 points), so that the right portion of the lens wall is almost negligible.

Crack initiation and rupture occurs in most cases at the point at the base and the tip of the lens. If rupture occurs in other areas, it is due to hidden defects in the material, which can facilitate the production of cracks (pores, inclusions, improper structure).

2.2.2. The influence of technology on the reliability of manufacturing and assembly of compensators

The most advanced manufacturing process (implementation and control) is the elastic elements of the semi-mechanical deformation of austenitic stainless steel sheet, followed by special rolls product having required geometry. Welding is made by welding the longitudinal ends by the process manual electric atmosphere of protective gases non-fusible electrode (WIG, **W**olfram **I**nert **G**as).

To increase the compensators reliability is important that the montage of elements to be made of welded joint pipe, which can be butt weld or corner weld (Fig. 8).

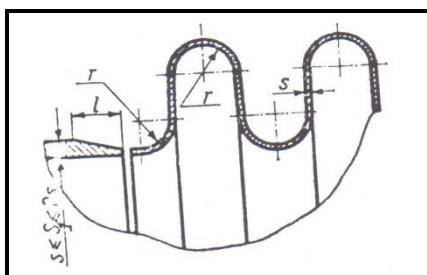

Fig. 8. a) butt weld

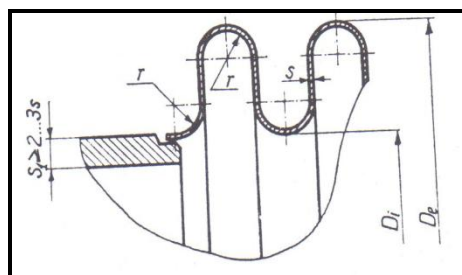

Fig. 8. b) corner weld

For the connection by welding, butt welding is preferable (Fig. 8. a) to weld the corner (Fig. 8. b). Weld seam for butt weld quality is equal to the mechanical strength of base material and a tight seal. This type of compensators does not require special supervision, and their maintenance is minor.

In Fig. 9. a, and care listed constructive measures to be taken in order to make minor maintenance: protection pipe inside the elastic element (Fig. 9. a), caps applied to the bottom of the lens to eliminate condensation (Fig. 9. b) protective sleeve on the outside of the elastic element (Fig. 9. c).

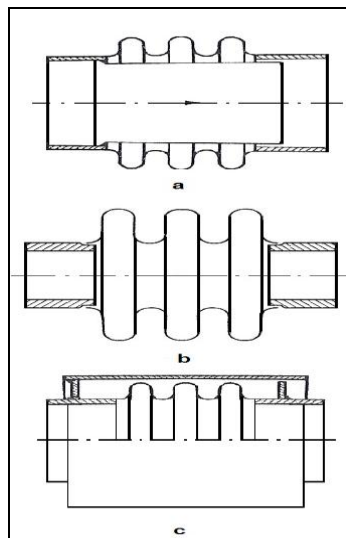

Fig. 9.

2.2.3. Influence of the reliability of maintenance compensators

Remedy by gouging (removing defects by local melting of the material and its removal with a jet of compressed air) of cracks in the wall of the lens or cords, welding and grinding addition of material. Repairs carried out in such permit to extend the life of the lenticular compensators average value of the number of cycles that occurred before the emergence of the first failure, i.e. until the first occurrence of cracks.

Arrival of the first cracks in elastic elements (lenses) are not automatically determine the disposal of compensators.

References

1. **Burlacu, G.**, "Engineering reliability and maintainability of industrial installations", Matrix Rom Publishing House, Bucharest, 2010;
2. **Dima, E.**, "Lenticular Expansion Compensators", Technical Publishing House, Bucharest, 1976;
3. **Burlacu, G., Dăneț, N., Bandrabur, C., Duminiță, T.**, "Reliability, maintainability and availability of technical systems", Editura Matrix Rom, Bucharest, 2005.